

TO-220

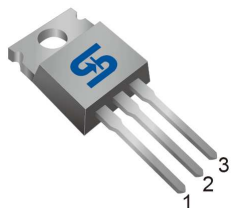

ITO-220

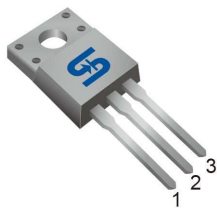

**Pin Definition:**

1. Gate
2. Drain
3. Source

**PRODUCT SUMMARY**

$V_{DS}$ (V)	$R_{DS(on)}$ ( $\Omega$ )	$I_D$ (A)
500	0.44 @ $V_{GS}=10V$	14

**General Description**

The TSM15N50 N-Channel enhancement mode Power MOSFET is produced by planar stripe DMOS technology. This advanced technology has been especially tailored to minimize on-state resistance, provide superior switching performance, and withstand high energy pulse in the avalanche and commutation mode. These devices are well suited for high efficiency switch mode power supply, electronic lamp ballast based on half bridge.

**Features**

- Low  $R_{DS(on)}$  0.44 $\Omega$  (Max.)
- Low gate charge typical @ 39nC (Typ.)
- Improve dv/dt capability

**Ordering Information**

Part No.	Package	Packing
TSM15N50CZ C0	TO-220	50pcs / Tube
TSM15N50CI C0	ITO-220	50pcs / Tube

**Block Diagram**

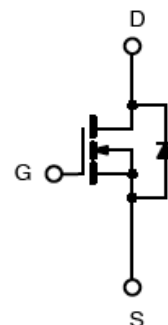

N-Channel MOSFET

**Absolute Maximum Rating** ( $T_a = 25^\circ C$  unless otherwise noted)

Parameter	Symbol	Limit	Unit
Drain-Source Voltage	$V_{DS}$	500	V
Gate-Source Voltage	$V_{GS}$	$\pm 30$	V
Continuous Drain Current ( $T_C=25^\circ C$ )	$I_D$	14	A
Pulsed Drain Current *	$I_{DM}$	56	A
Peak Diode Recovery dv/dt (Note 3)	dv/dt	4.5	V/ns
Single Pulse Avalanche Energy (Note 2)	$E_{AS}$	630	mJ
Avalanche Current (Repetitive) (Note 1)	$I_{AR}$	14	A
Repetitive Avalanche Energy (Note 1)	$E_{AR}$	23.1	mJ
Operating Junction Temperature	$T_J$	150	$^\circ C$
Storage Temperature Range	$T_{STG}$	-55 to +150	$^\circ C$

\* Limited by maximum junction temperature

### Thermal Performance

Parameter	Symbol	TO-220	ITO-220	Unit
Thermal Resistance - Junction to Case	$R\theta_{JC}$	0.54	2.34	°C/W
Thermal Resistance - Junction to Ambient	$R\theta_{JA}$	62.5		

Notes: Surface mounted on FR4 board  $t \leq 10\text{sec}$

### Electrical Specifications (Tc = 25°C unless otherwise noted)

Parameter	Conditions	Symbol	Min	Typ	Max	Unit
<b>Static</b>						
Drain-Source Breakdown Voltage	$V_{GS} = 0V, I_D = 250\mu A$	$BV_{DSS}$	500	--	--	V
Drain-Source On-State Resistance	$V_{GS} = 10V, I_D = 7.0A$	$R_{DS(ON)}$	--	0.35	0.44	$\Omega$
Gate Threshold Voltage	$V_{DS} = V_{GS}, I_D = 250\mu A$	$V_{GS(TH)}$	2.0	--	4.0	V
Zero Gate Voltage Drain Current	$V_{DS} = 500V, V_{GS} = 0V$	$I_{DSS}$	--	--	1	$\mu A$
Gate Body Leakage	$V_{GS} = \pm 30V, V_{DS} = 0V$	$I_{GSS}$	--	--	$\pm 100$	nA
Forward Transconductance	$V_{DS} = 30V, I_D = 7.0A$	$g_{fs}$	--	10	--	S
Diode Forward Voltage	$I_S = 14A, V_{GS} = 0V$	$V_{SD}$	--	--	1.5	V
<b>Dynamic<sup>b</sup></b>						
Total Gate Charge	$V_{DS} = 400V, I_D = 14A, V_{GS} = 10V$	$Q_g$	--	39	--	nC
Gate-Source Charge		$Q_{gs}$	--	11	--	
Gate-Drain Charge		$Q_{gd}$	--	8.6	--	
Input Capacitance	$V_{DS} = 25V, V_{GS} = 0V, f = 1.0\text{MHz}$	$C_{iss}$	--	2263	--	pF
Output Capacitance		$C_{oss}$	--	211	--	
Reverse Transfer Capacitance		$C_{rss}$	--	6.4	--	
<b>Switching<sup>c</sup></b>						
Turn-On Delay Time	$V_{DD} = 250V, I_D = 14A, R_G = 25\Omega$	$t_{d(on)}$	--	65	--	nS
Turn-On Rise Time		$t_r$	--	55	--	
Turn-Off Delay Time		$t_{d(off)}$	--	144	--	
Turn-Off Fall Time		$t_f$	--	58	--	
Reverse Recovery Time	$V_{GS} = 0V, I_S = 14A,$	$t_{fr}$	--	381	--	nS
Reverse Recovery Charge	$di/dt = 100A/\mu s$	$Q_{fr}$	--	4.4	--	$\mu C$

#### Notes:

1. Repetitive Rating: Pulse Width Limited by Maximum Junction Temperature
2.  $V_{DD} = 50V, I_{AS} = 14A, L = 5.9\text{mH}, R_G = 25\Omega, \text{Starting } T_J = 25^\circ\text{C}$
3.  $I_{SD} \leq 14A, di/dt \leq 200A/\mu S, V_{DD} \leq BV, \text{Starting } T_J = 25^\circ\text{C}$
4. Pulse test: pulse width  $\leq 300\mu S, \text{duty cycle } \leq 2\%$
5. b For design reference only, not subject to production testing.
6. c Switching time is essentially independent of operating temperature.



**Electrical Characteristics Curve** ( $T_c = 25^\circ\text{C}$ , unless otherwise noted)

**Output Characteristics**

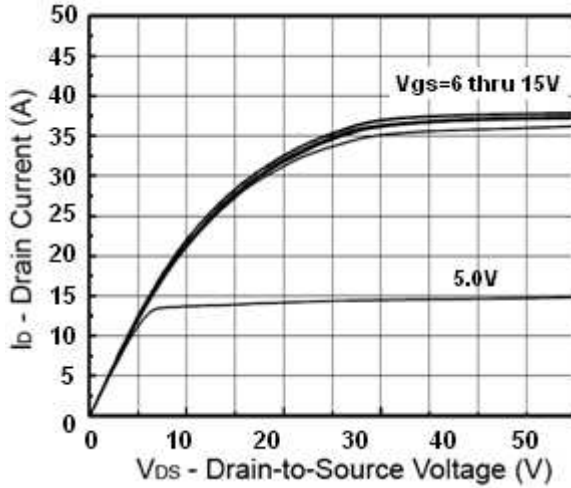

**Transfer Characteristics**

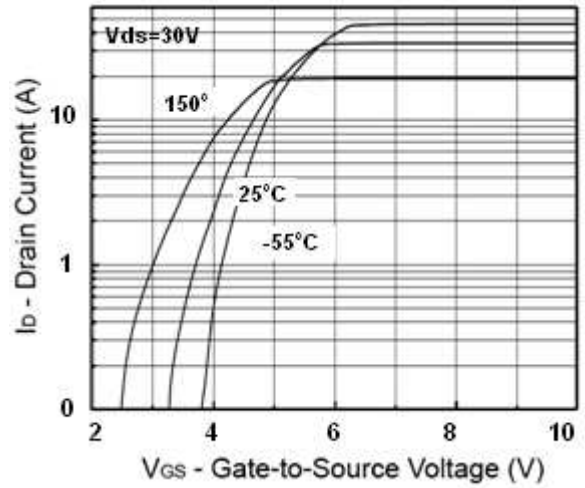

**On-Resistance vs. Drain Current**

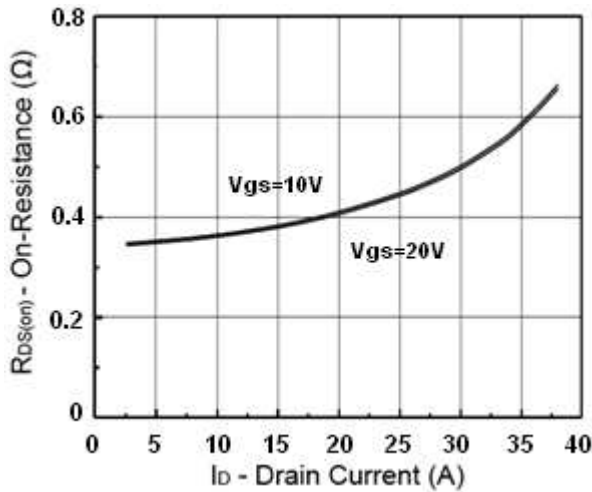

**Gate Charge**

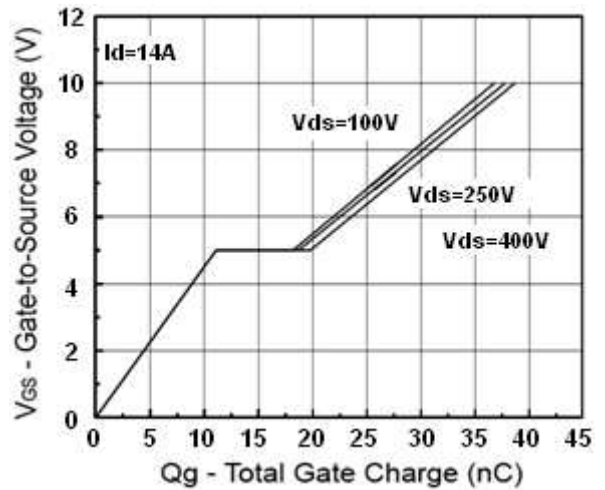

**On-Resistance vs. Junction Temperature**

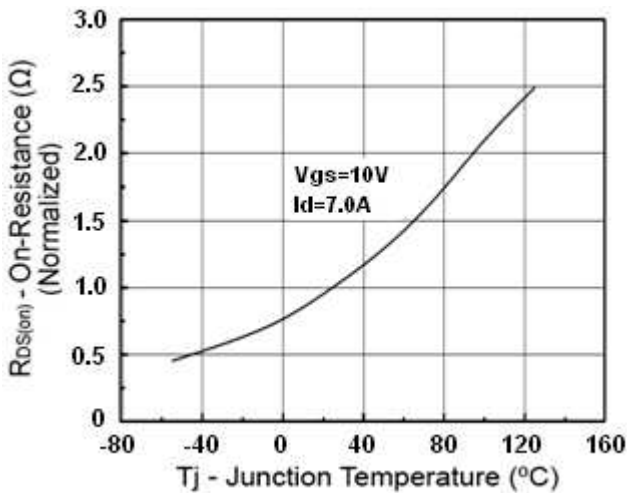

**Source-Drain Diode Forward Voltage**

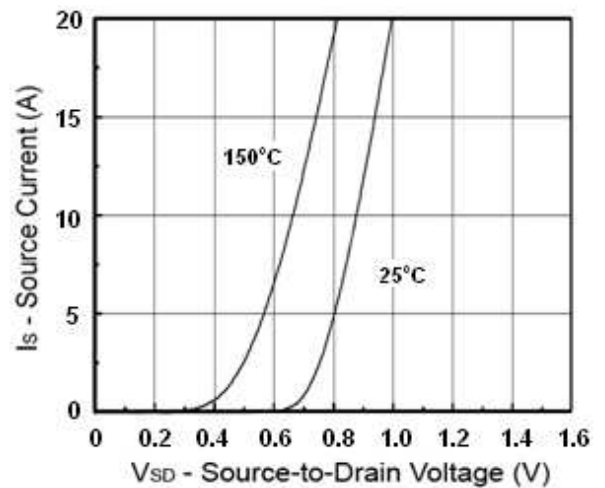

**Electrical Characteristics Curve** ( $T_a = 25^\circ\text{C}$ , unless otherwise noted)

**Drain Current vs. Case Temperature**

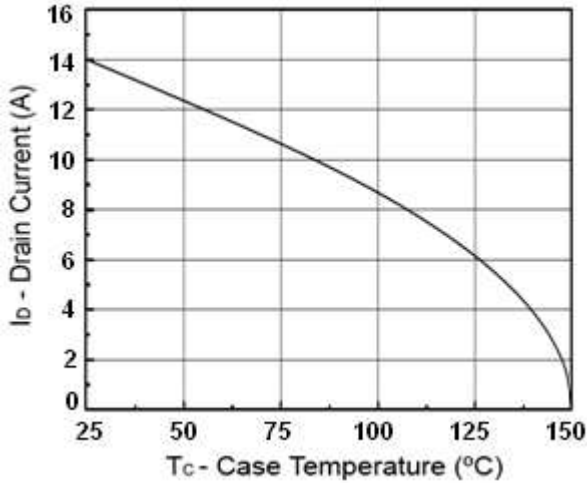

**$BV_{DSS}$  vs. Junction Temperature**

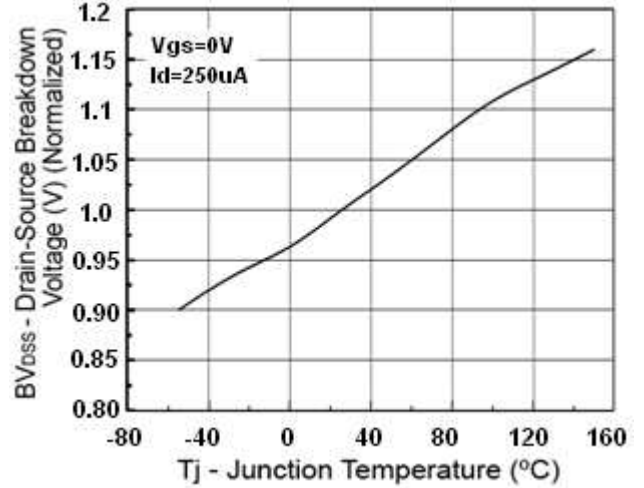

**Maximum Safe Operating Area**

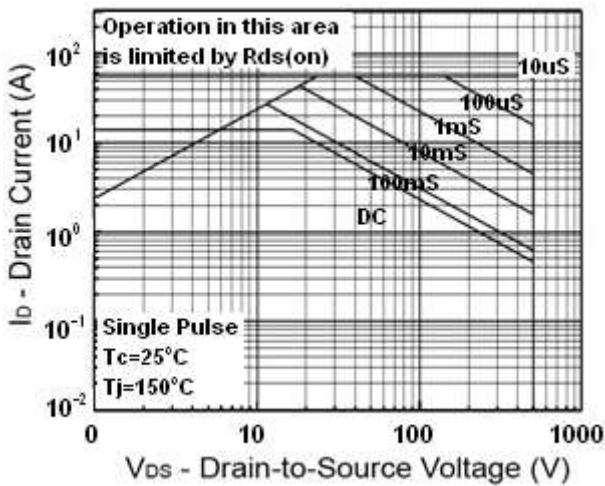

**Capacitance vs. Drain-Source Voltage**

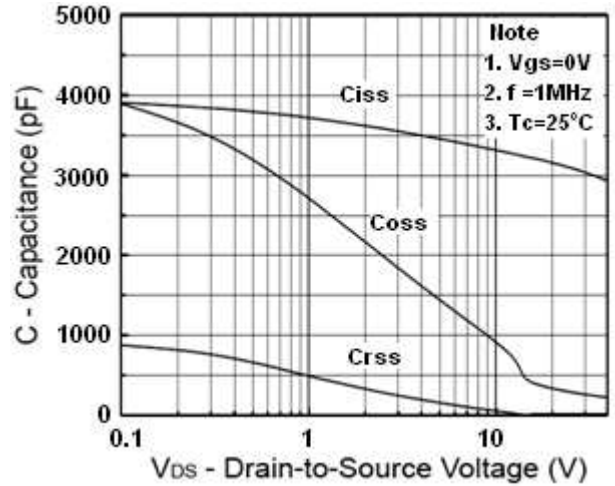

**Maximum Safe Operating Area (ITO-220)**

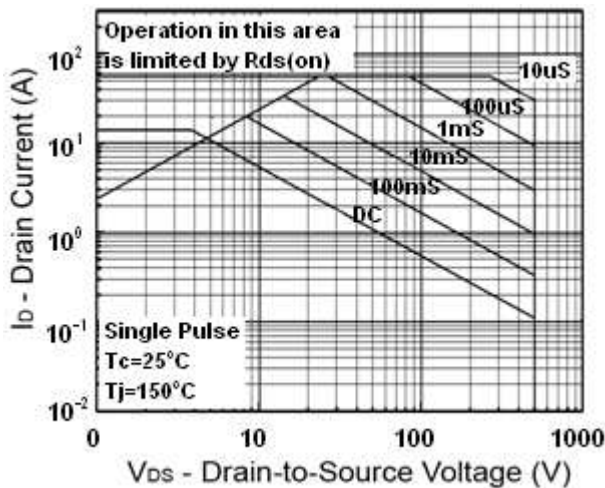

**Electrical Characteristics Curve** ( $T_a = 25^\circ\text{C}$ , unless otherwise noted)

**Normalized Thermal Transient Impedance, Junction-to-Ambient**

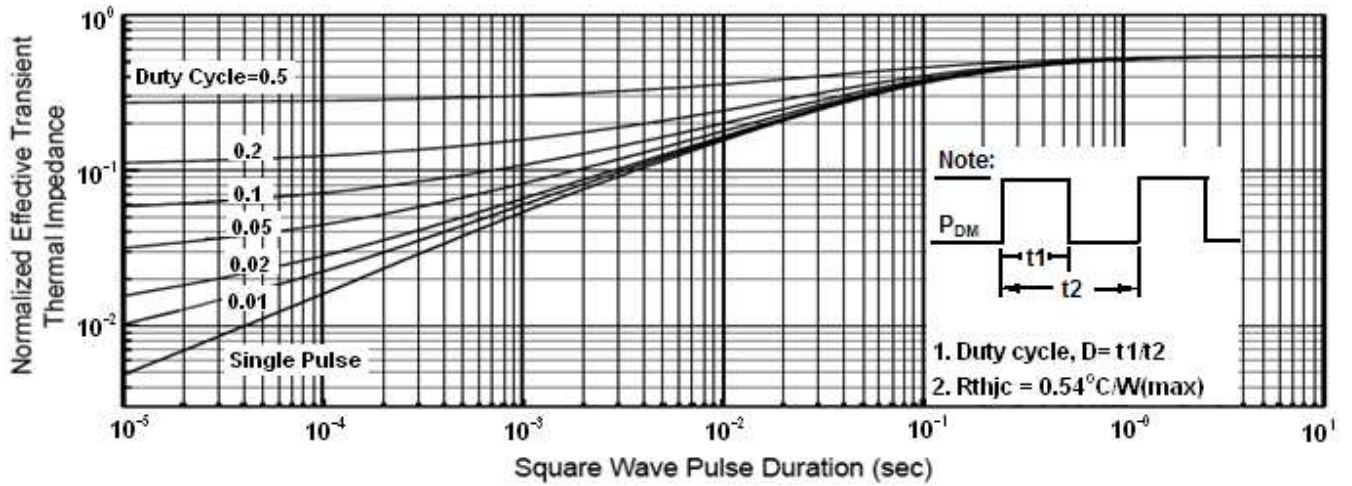

**Normalized Thermal Transient Impedance, Junction-to-Ambient(ITO-220)**

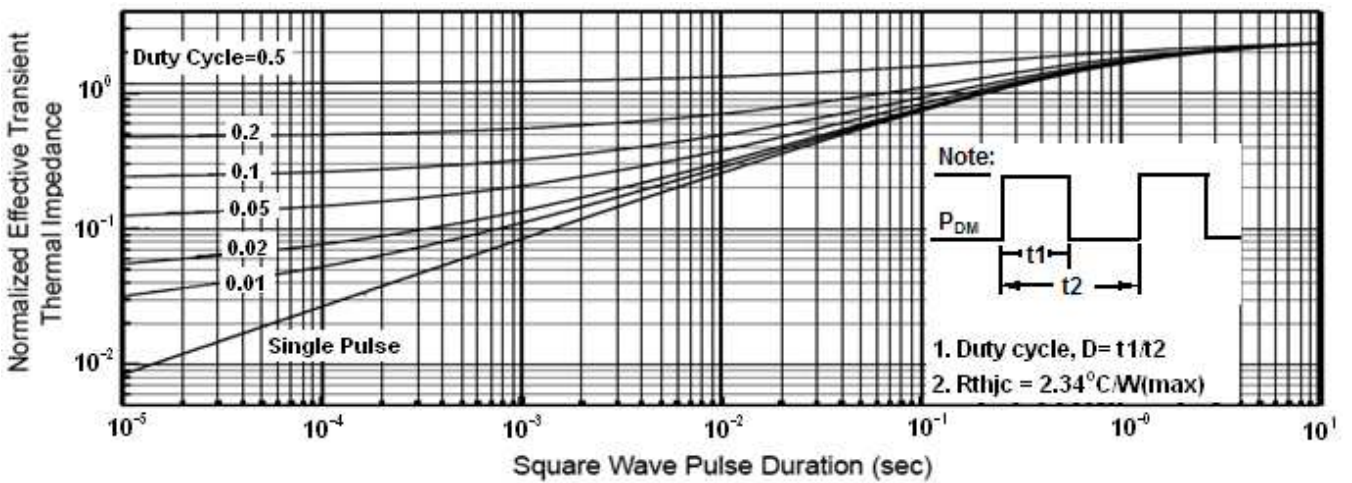

### Gate Charge Test Circuit & Waveform

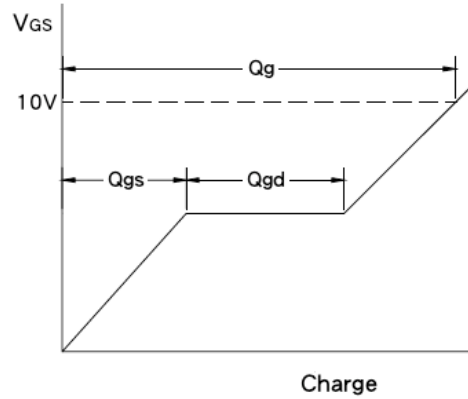
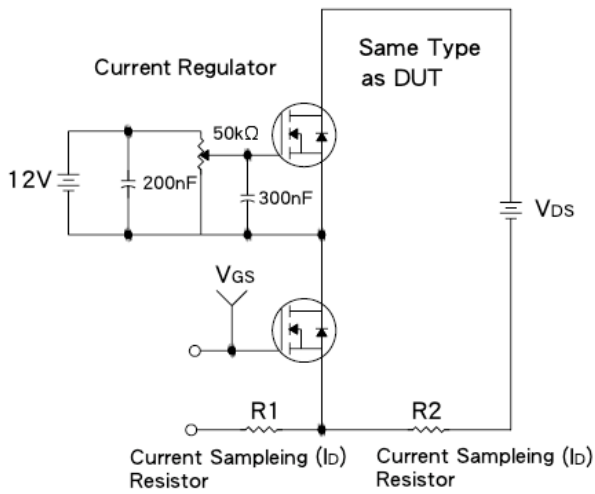

### Resistive Switching Test Circuit & Waveform

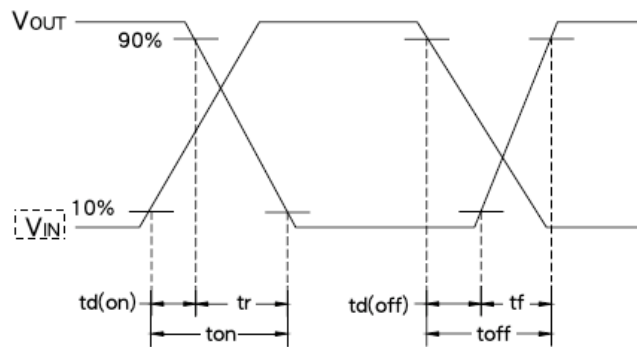
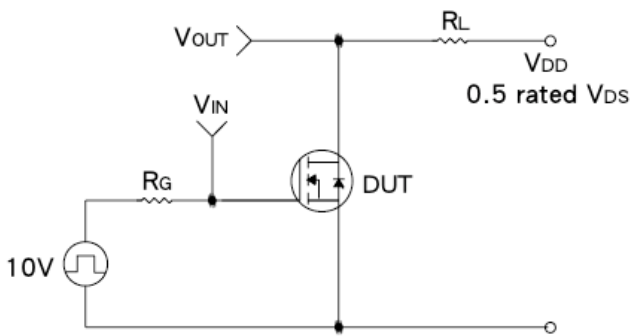

### EAS Test Circuit & Waveform

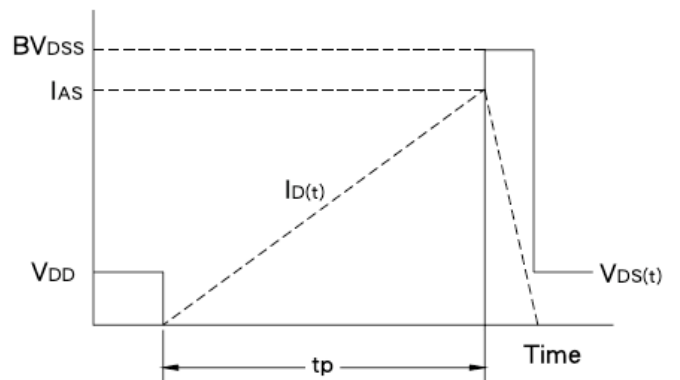
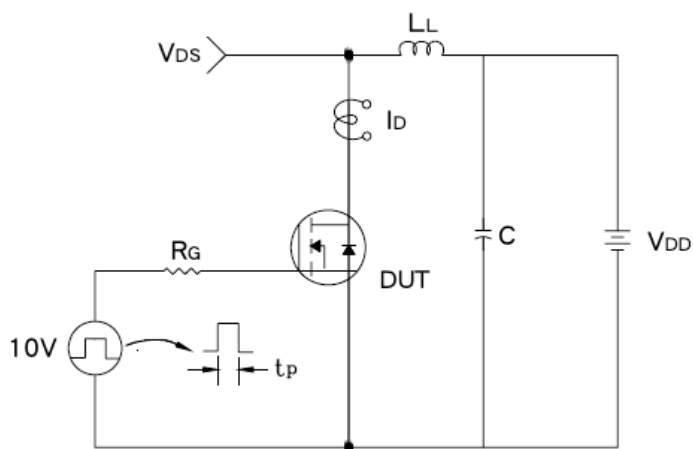

**Diode Reverse Recovery Time Test Circuit & Waveform**

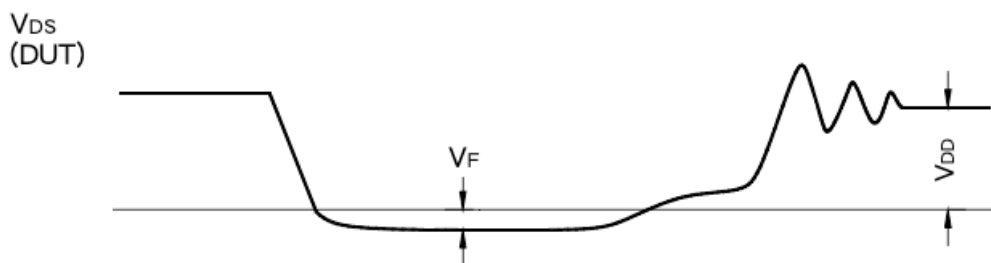
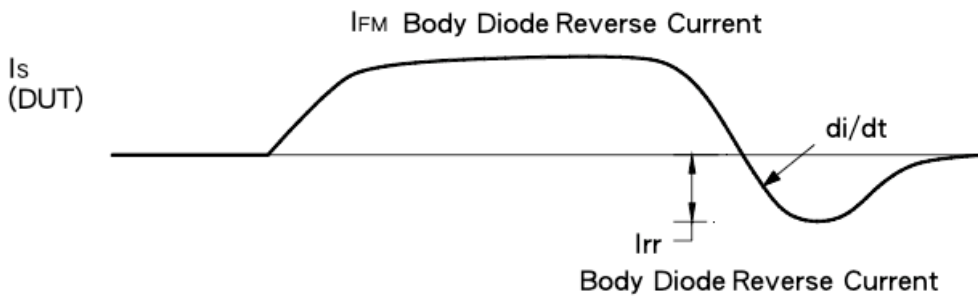
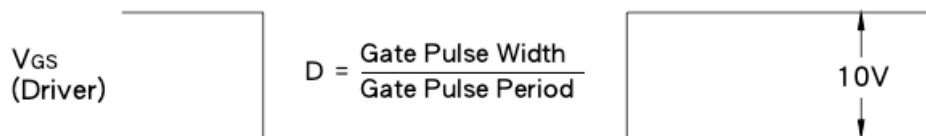
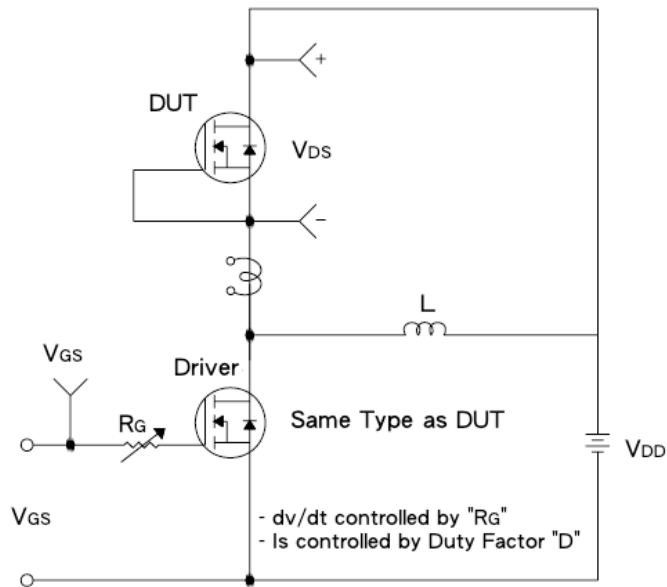

**TO-220 Mechanical Drawing**

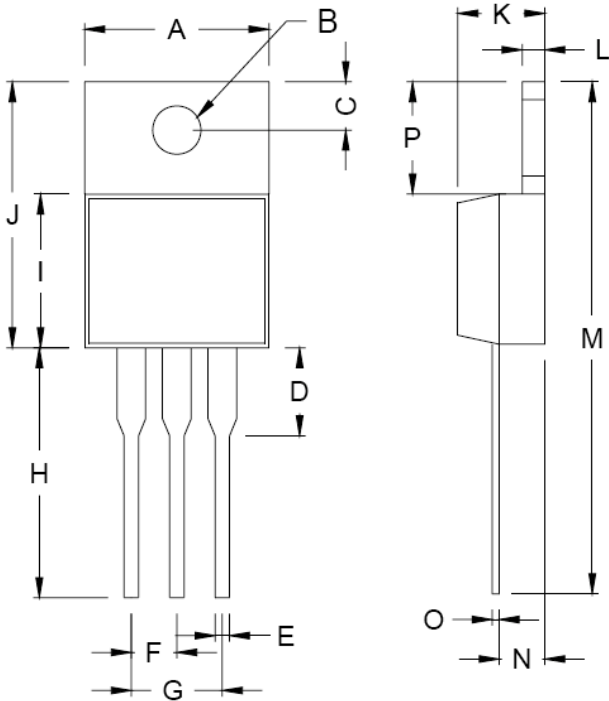

TO-220 DIMENSION				
DIM	MILLIMETERS		INCHES	
	MIN	MAX	MIN	MAX
A	10.00	10.50	0.394	0.413
B	3.74	3.91	0.147	0.154
C	2.44	2.94	0.096	0.116
D	--	6.35	--	0.250
E	0.38	1.10	0.015	0.043
F	2.34	2.71	0.092	0.107
G	4.69	5.43	0.185	0.214
H	12.70	14.73	0.500	0.580
I	8.38	9.38	0.330	0.369
J	14.22	16.51	0.560	0.650
K	3.55	4.82	0.140	0.190
L	1.16	1.40	0.046	0.055
M	27.70	29.62	1.091	1.166
N	2.03	2.92	0.080	0.115
O	0.25	0.61	0.010	0.024
P	5.84	6.85	0.230	0.270



### ITO-220 Mechanical Drawing

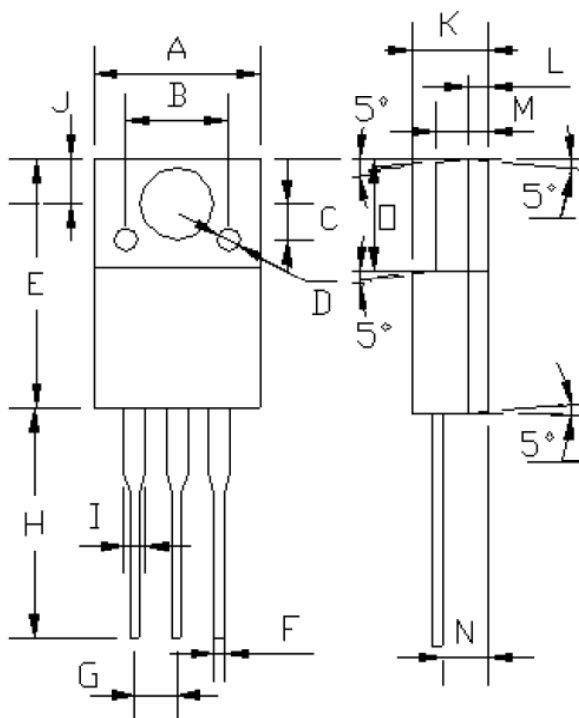

ITO-220 DIMENSION				
DIM	MILLIMETERS		INCHES	
	MIN	MAX	MIN	MAX
A	10.04	10.07	0.395	0.396
B	6.20 (typ.)		0.244 (typ.)	
C	2.20 (typ.)		0.087 (typ.)	
D	§ 1.40 (typ.)		§ 0.055 (typ.)	
E	15.0	15.20	0.591	0.598
F	0.52	0.54	0.020	0.021
G	2.35	2.73	0.093	0.107
H	13.50	13.55	0.531	0.533
I	1.11	1.49	0.044	0.058
J	2.60	2.80	0.102	0.110
K	4.49	4.50	0.176	0.177
L	1.15 (typ.)		0.045 (typ.)	
M	3.03	3.05	0.119	0.120
N	2.60	2.80	0.102	0.110
O	6.55	6.65	0.258	0.262

### Notice

Specifications of the products displayed herein are subject to change without notice. TSC or anyone on its behalf, assumes no responsibility or liability for any errors or inaccuracies.

Information contained herein is intended to provide a product description only. No license, express or implied, to any intellectual property rights is granted by this document. Except as provided in TSC's terms and conditions of sale for such products, TSC assumes no liability whatsoever, and disclaims any express or implied warranty, relating to sale and/or use of TSC products including liability or warranties relating to fitness for a particular purpose, merchantability, or infringement of any patent, copyright, or other intellectual property right.

The products shown herein are not designed for use in medical, life-saving, or life-sustaining applications. Customers using or selling these products for use in such applications do so at their own risk and agree to fully indemnify TSC for any damages resulting from such improper use or sale.